

鉄鉢形
Wa-nari:
Circle Shape

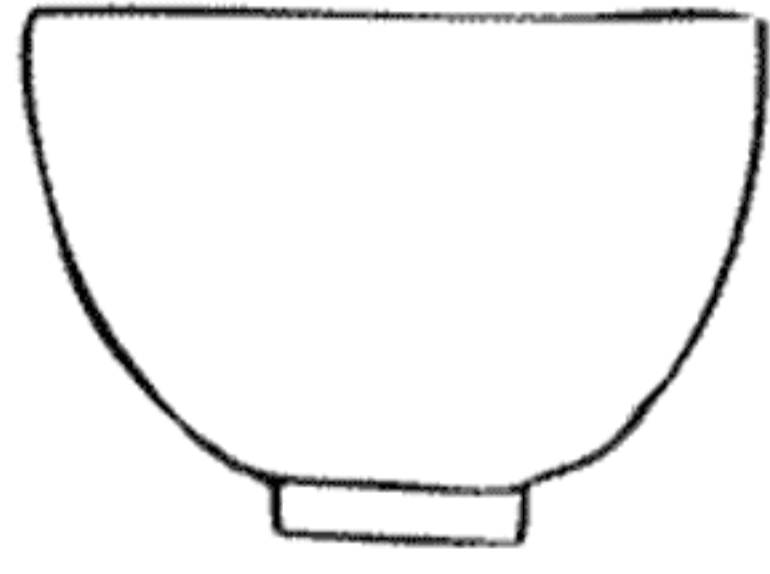

椀形
Wan-nari:
Wooden Bowl Shape



呉記型
Goki-gata:
Goki Type

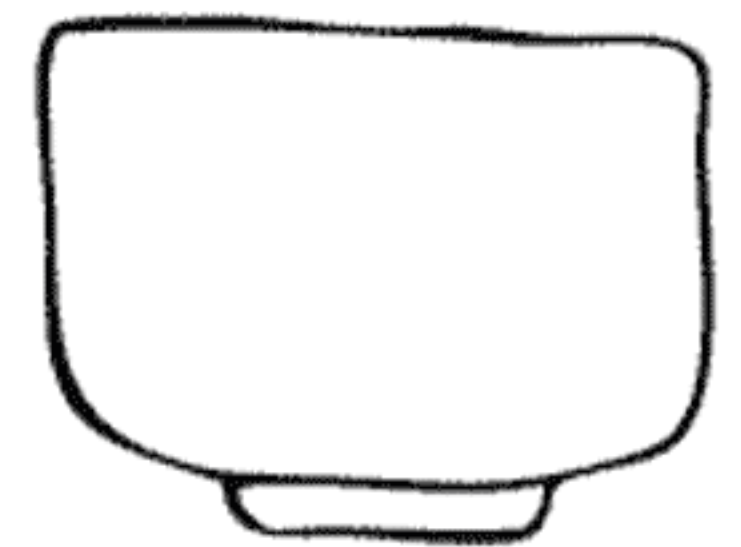

半筒型
Han tsutsu-gata:
Half Cylinder Shape

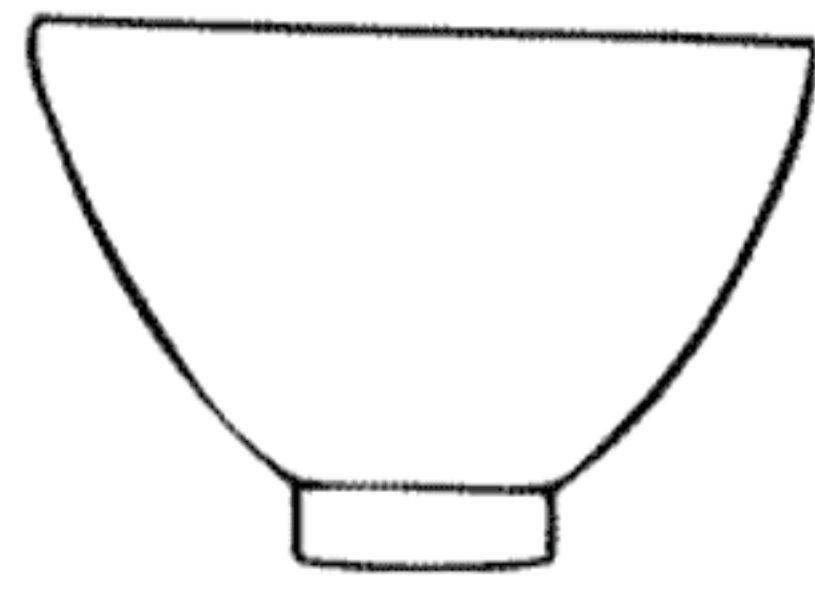

杉形
Sugi-nari:
Cedar Shape

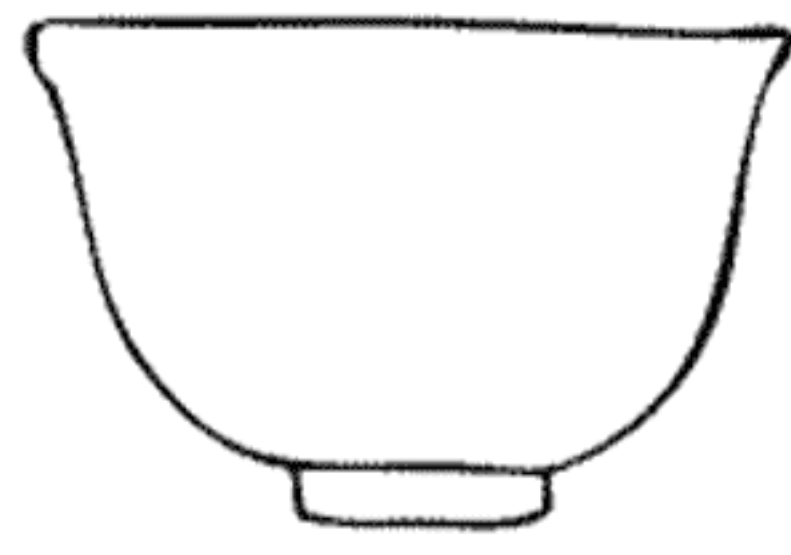

Komogai-nari:
Komogai
Shape

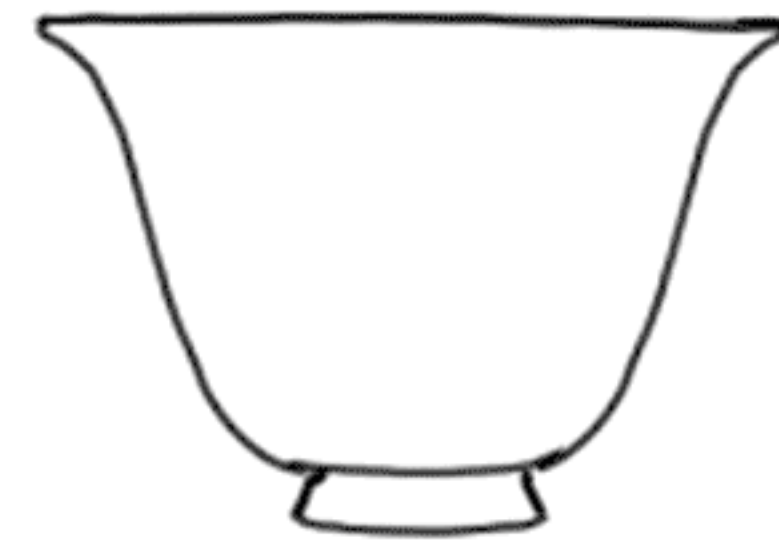

端反り型
Hatazori-gata:
Curving Lip Type

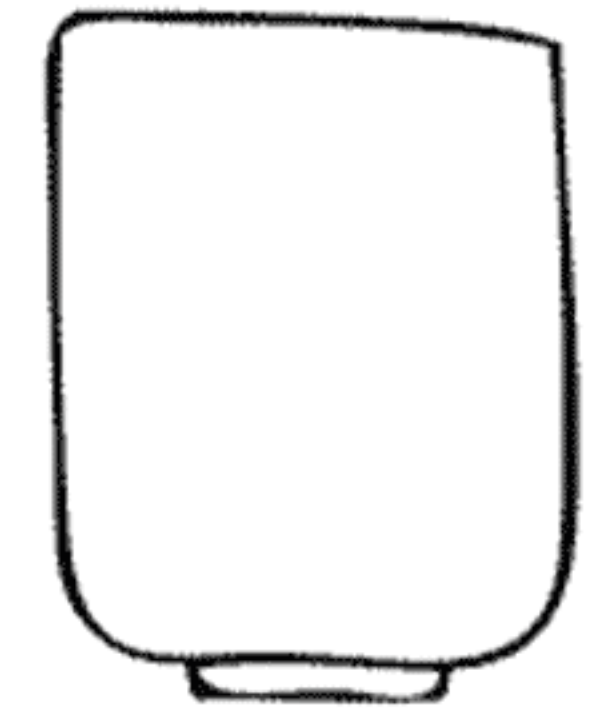

筒型
Tsutsu-gata:
Cylinder Type

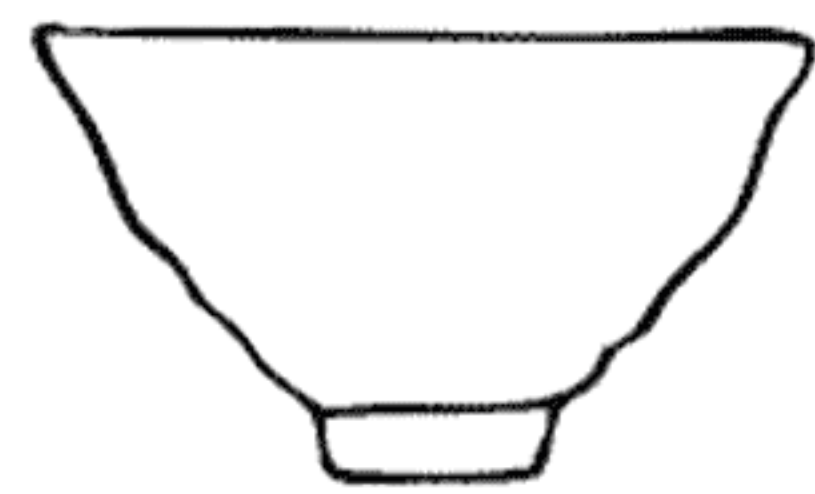

井戸型
Ido-gata:
Ido or Well Type

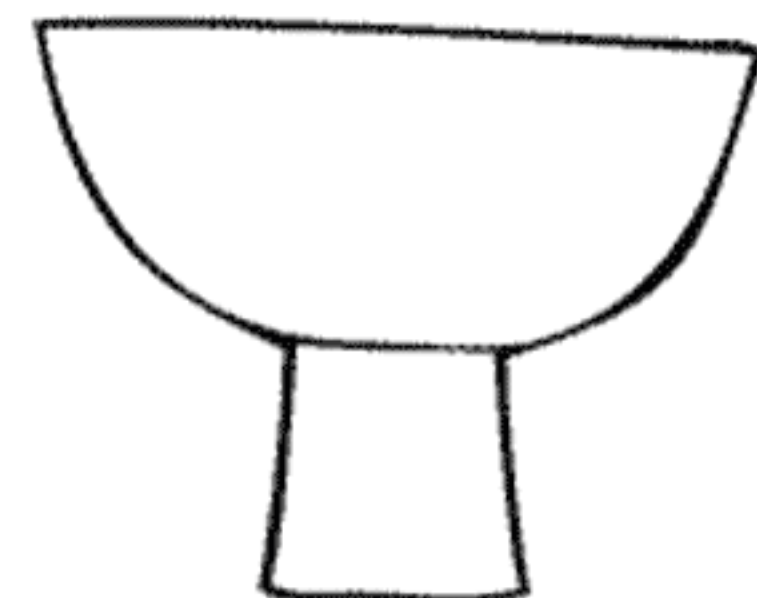

馬上杯
Bajyohai:
Rider's Cup



胴締
Dojimari-gata:
Waist Type



碁笥底型
Gokezoko-gata:
Go Stone Box Type



天目型
Tenmoku-gata:
Tenmoku Type



平形, Hiragata: Flat Shape
Wide low bowls are also known as
夏茶碗, Natsu-jawan: Summer Tea Bowls



馬盥
Badarai:
Horse Bucket Shape



沓形
Kutsu-gata:
Clog or Shoe
Shape



砂浜形
Suhama-gata:
Shoreline Type



桃形
Momo-gata:
Peach Shape



筆洗形
Hissen-gata:
Brush Washer
Shape



編笠
Amikasa:
Amikasa Straw
Hat Type



三角形
Sankaku-gata:
Triangular Shape

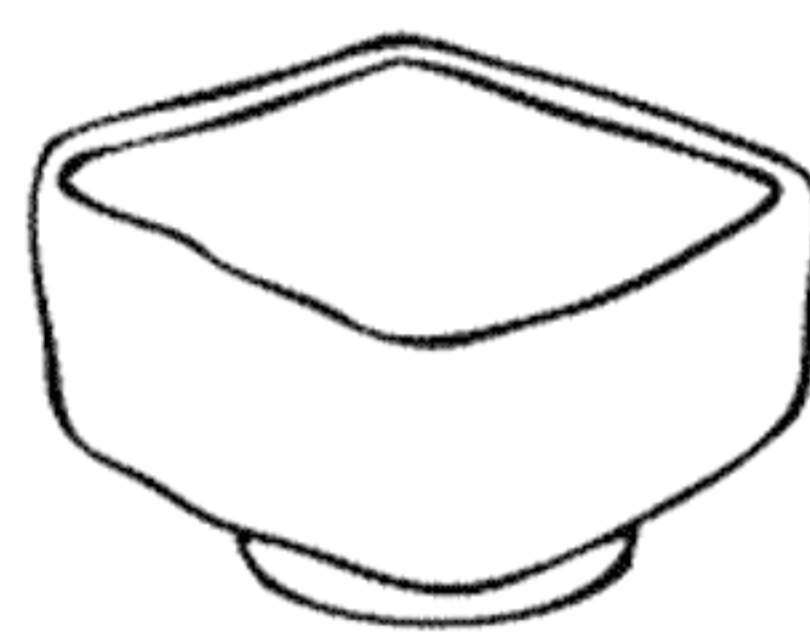

四方形
Shiho-gata:
Four Sided Shape

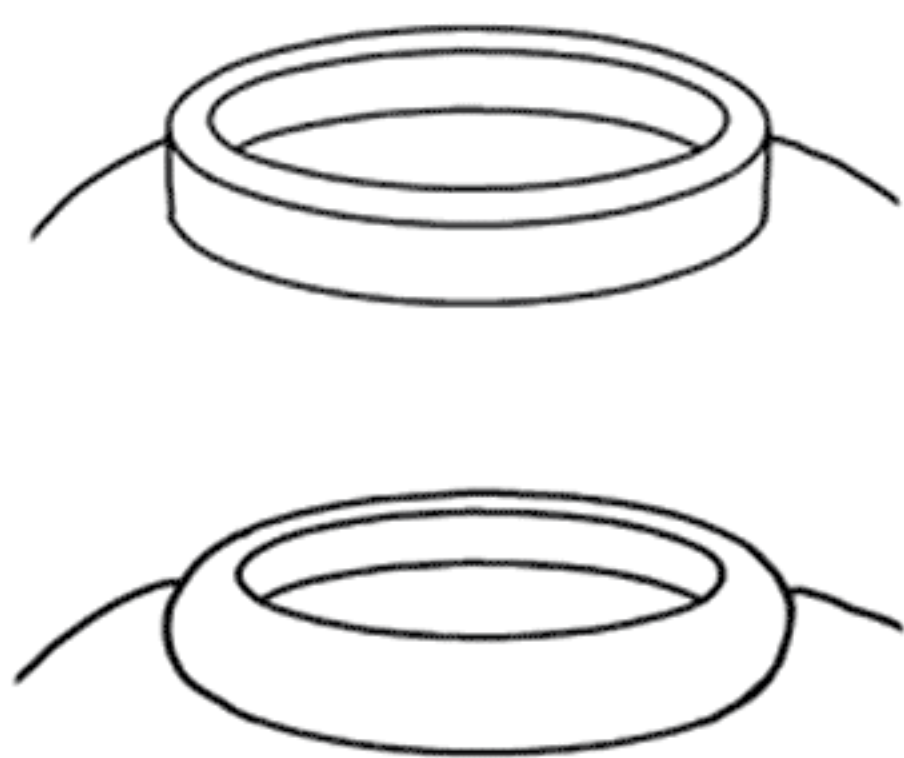

輪高台
Wa Kodai:
Ring Foot

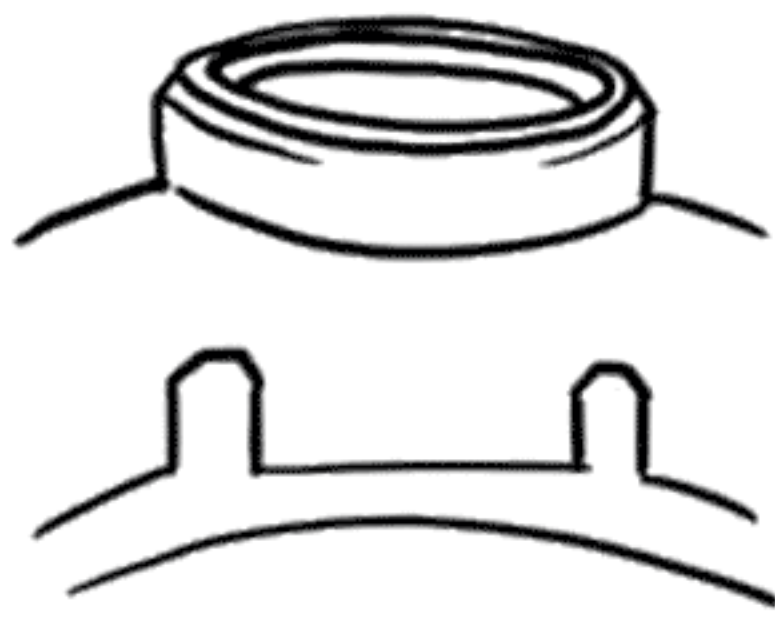

蛇ノ目高台
or 普通高台
Janome or
Futsuu Kodai:
Snake's Eye Foot

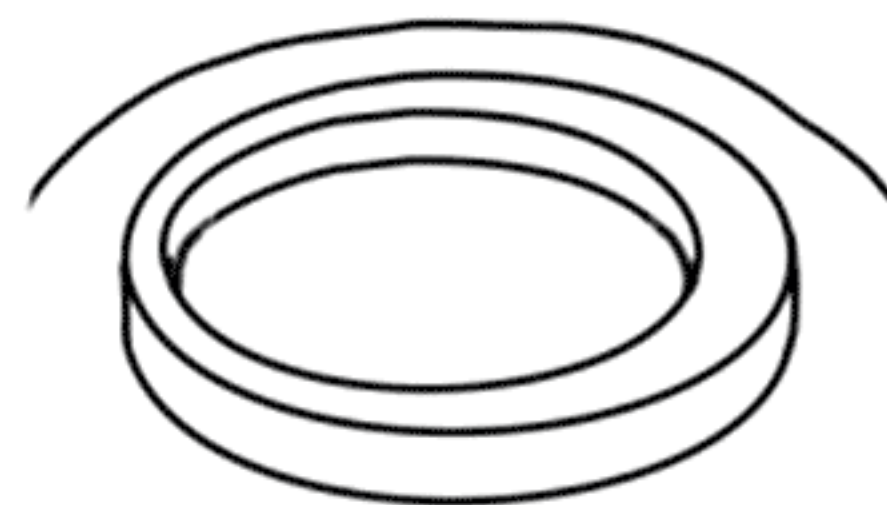

三日月高台
Mikazuki Kodai:
Crescent Moon
Foot

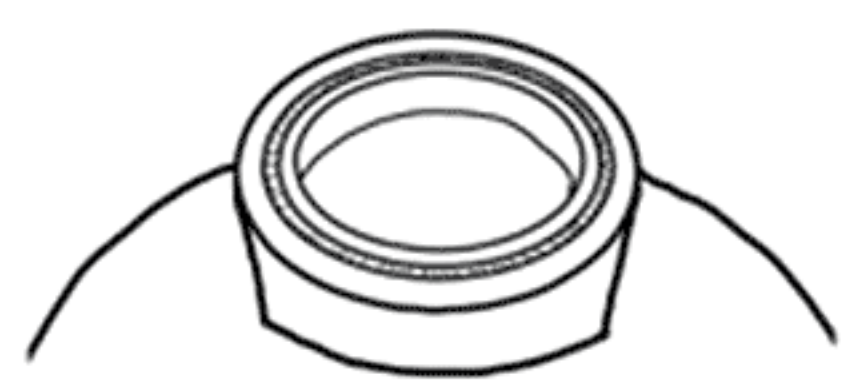
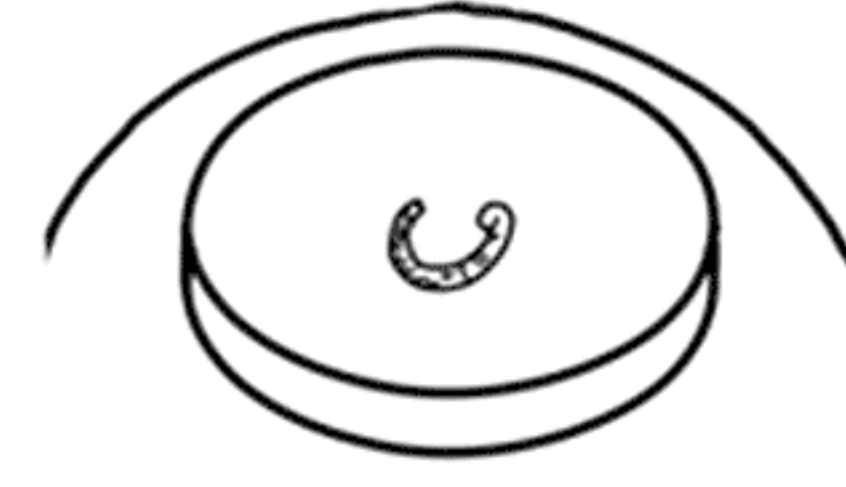
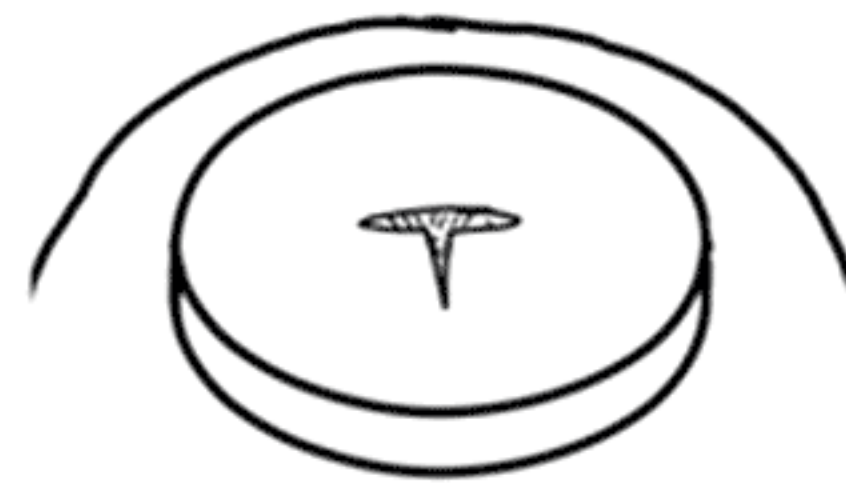
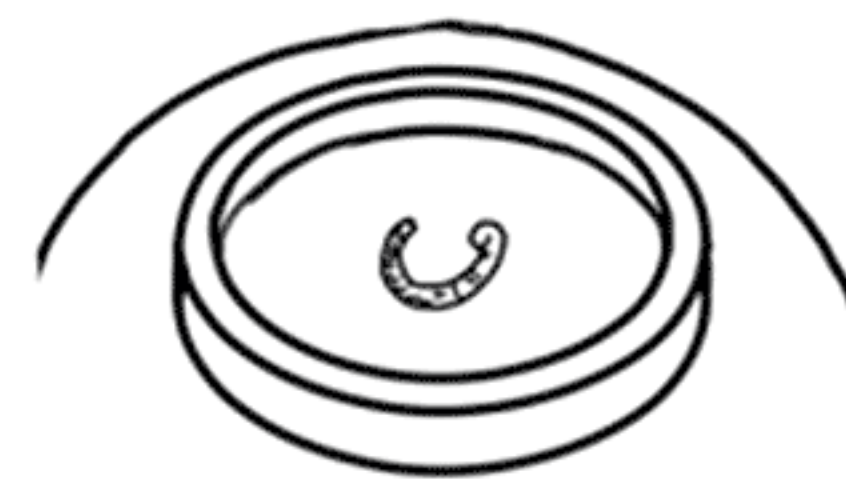
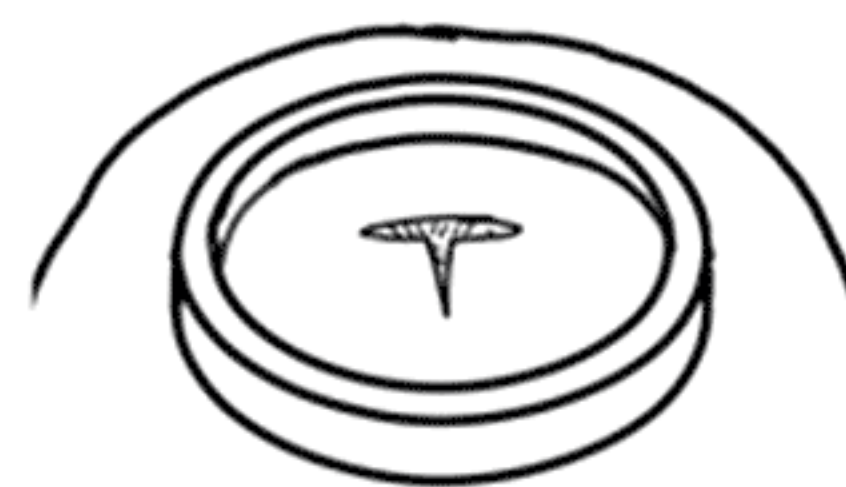

二重高台
Niju Kodai:
Double Foot



撥高台
Bachi Kodai:
Shamisen Plectrum
Foot

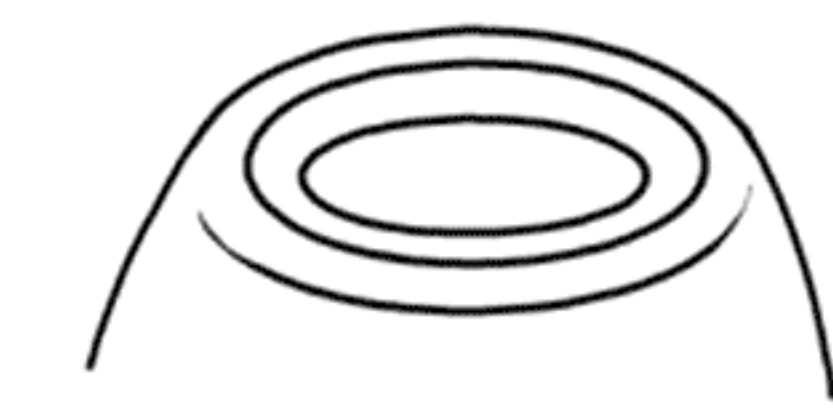

碁石高台
Gokezoko-Kodai:
Go Stone Box Foot

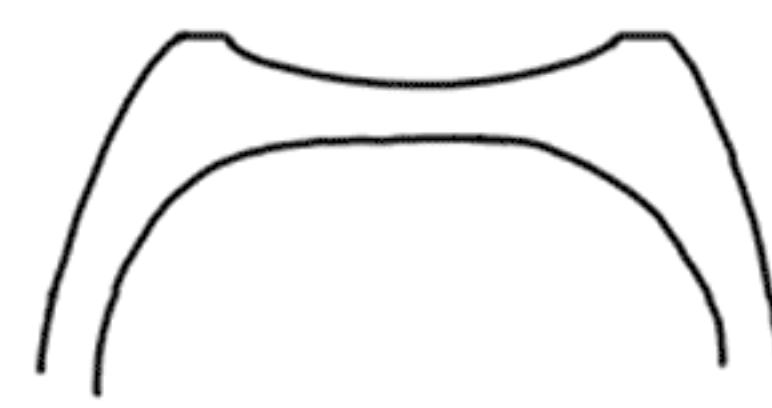

釘彫高台
Kugibori Kodai:
Nail Carved Foot



竹の節高台
Takenofushi Kodai:
Bamboo Node Foot

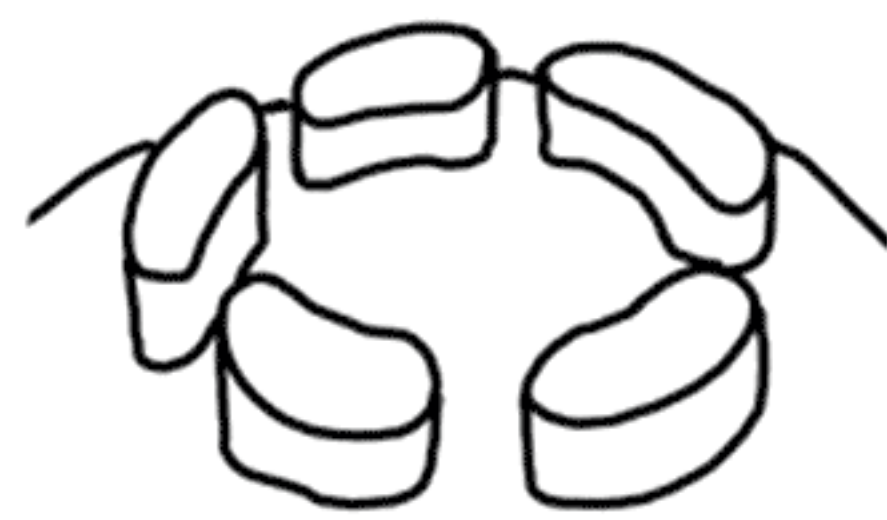

桜高台
Sakura Kodai:
Cherry Blossom
Foot

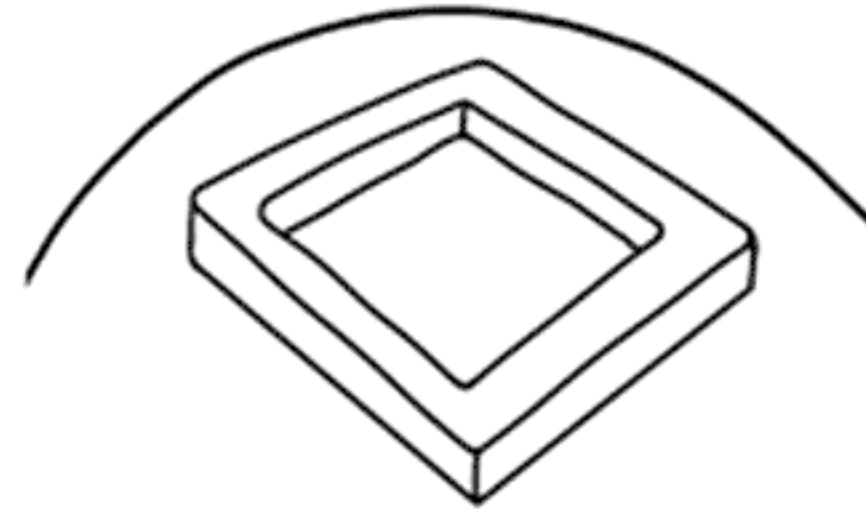

四方高台
Shiho Kodai:
Four Directions
Foot

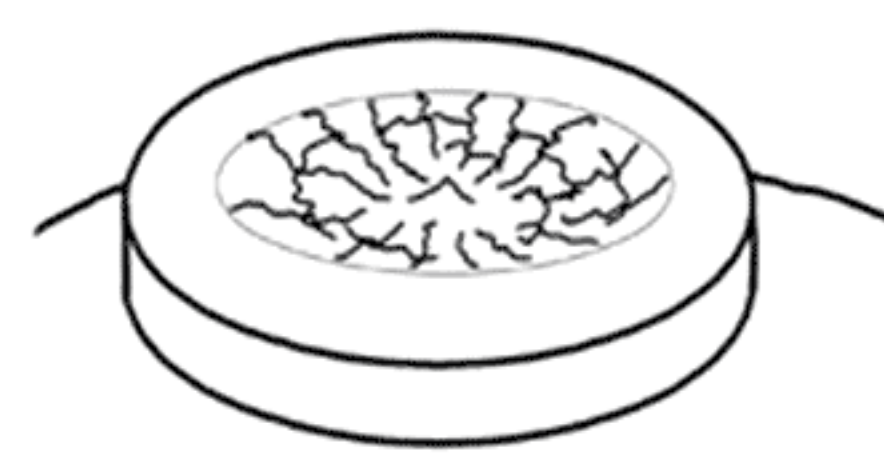

縮緬高台
Chirimen Kodai:
Crinkled Cloth Foot



割高台
Wari Kodai:
Split Foot



割一文字高台
Wariichimonji
Kodai: Two Split
Foot



割十文字高台
Warijumonji Kodai:
Four Split Foot

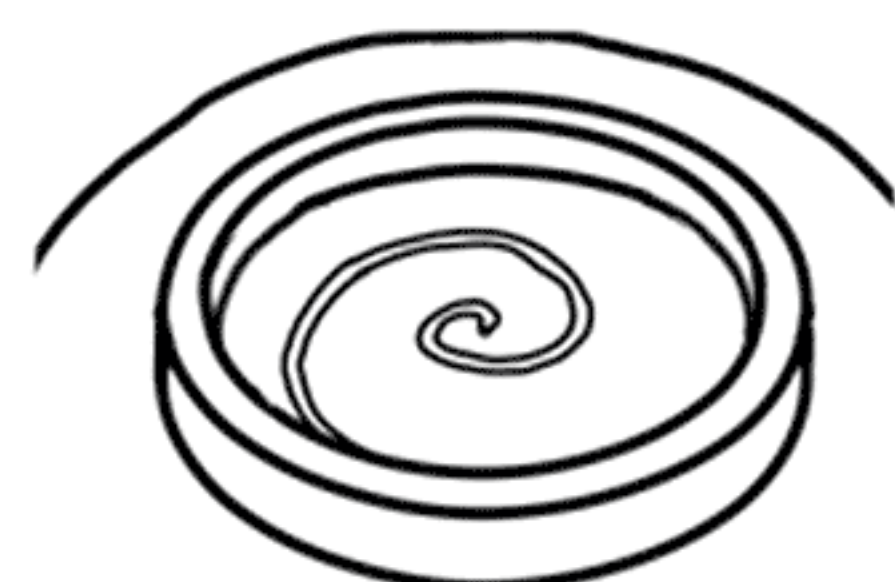

貝尻高台
Kaijiri Kodai:
Spiral Shell Foot



切高台
Kiri Kodai:
Cut Foot



釘彫高台
Kiriichimonji Kodai:
Bar Cut Foot



切十文字高台
Kirijumonji
Kodai:
Cross Cut Foot



渦巻高台
Uzumaki Kodai:
Whirlpool Foot



兜巾
Token kodai:
Helmet Foot